

Materials + Finishes



ERG
INTERNATIONAL

The all-encompassing guide to
all of ERG's finishes,
colors, materials and
information. Endless
possibilities to customize
your tables and seating with
your exact look.

ERG
INTERNATIONAL

CONTENTS

Finish Info.....	4
FINISHES	
Metal Finishes.....	6
Wood Stain Colors.....	7
Edges & Profiles.....	8
TABLE TOP MATERIALS	
Laminate.....	10
Wood Veneer & Butcher Block.....	11
Acrylic.....	12
Solid Surface.....	14
COLORS	
Poly Shells.....	16
TEXTILES	
Fabric Vendors & Grade Info.....	18
GENERAL INFO	
Care & Instructions.....	19

FINISH INFORMATION

TABLE TOPS

All table tops are 1.25" with the exception of Elliot at .75", overall thickness unless otherwise noted. Core material is high density particle board with no added urea formaldehyde. Backing material is installed to the underside of each table. All glue used in our process is 100% water soluble, nontoxic and environmentally friendly.

Table tops can be finished in your choice of laminate, wood veneer, composite, or natural stone (where available).

T-Nuts and Screws: ERG never uses wood screws. All bases are connected to table tops with metal inserts. Steel machine screws are then inserted into metal inserts, for a metal-to-metal connection.

Laminate samples can be obtained from these manufacturers by contacting them direct at the numbers or websites listed below:

LAMINATES

ERG offers over 1000 standard laminate choices from Nevamar, Wilsonart, Formica and Pionite. To verify if your laminate is standard with ERG, please call ERG Customer Service. Some laminates carry a premium upcharge. ERG can "special order" laminates made by other manufacturers. Please call Customer Service with your request.

PANOLAM	877-726-6526	www.panolam.com
(includes Navamar, Panolam, and Pionite brands)		
WILSONART	800-433-3222	samples.wilsonartcontract.com
FORMICA	800-367-6422	www.formica.com

Other Laminate Venders Available Upon Request.

SOLID SURFACE

ERG offers Solid Surface and Stone tops in many selections.

Call ERG Customer Service with your requirements.

3MM PVC EDGE / LAMINATE CROSS REFERENCE GUIDE

ERG has put together the following laminate guide to assist our customers in choosing laminates that closely match ERG's PVC edge colors. ERG carries many in stock laminates.

Please call Customer Service or e-mail literature@erginternational.com for ERG laminate colors.

PVC SOLID COLORS	COORDINATING LAMINATE	PVC WOOD COLORS	COORDINATING LAMINATE
ALMOND	WILSONART NATURAL ALMOND D30-60	AMBER MAPLE	WILSONART KENSINGTON MAPLE 10776-60
AMAZON	NO SUGGESTION	ASHEN RIBBONWOOD	FORMICA ASHEN RIBBONWOOD 8839-58
BLACK	WILSONART BLACK 1595-60	BEIGEWOOD	WILSONART BEIGEWOOD 7850-60
BURGUNDY	PIONITE PLUM SP402-SD	BLEACHED LEGNO	FORMICA BLEACHED LEGNO 8845-58
CHARCOAL	WILSONART SLATE GREY D91-60	BRAZILWOOD	WILSONART BRAZILWOOD 7946-38
CREAM	WILSONART ALABASTER D431-60	CHOCOLATE PEAR	WILSONART COCOBALA 7942K-07
DARK BROWN	WILSONART COFFEE BEAN D495-60	COLOMBIAN WALNUT	WILSONART COLOMBIAN WALNUT 7943K-07
GRAY	FORMICA FOG 961-58	CROWN CHERRY	NEVAMAR CROWN CHERRY W8294T
KHAKI BROWN	WILSONART KHAKI BROWN D50-60	MAPLE MULTIPLEX	NO SUGGESTION
PEPPERDUST	WILSONART PEPPERDUST D327-60	MONTICELLO MAPLE	WILSONART MONTICELLO MAPLE 7925-38
SAND	WILSONART HAZE D97-60	MYRIAD RIBBONWOOD	FORMICA MYRIAD RIBBONWOOD 863-58
WHITE	FORMICA BRITE WHITE 459-58	NATURAL RIBBONWOOD	NO SUGGESTION
		SARUM TWILL	FORMICA SARUM TWILL 8827-58
		SILVER METALLIC	WILSONART SATIN STAINLESS 4830K-18
		SMOKE	WILSONART ASIAN NIGHT 7949K-18
		TITANIUM	WILSONART TITANIUM EV 4810-60
		WALNUT HEIGHTS	WILSONART WALNUT HEIGHTS 7965K-12
		WILD CHERRY	NEVAMAR SOVEREIGN CHERRY W8325T

To obtain a metal paint or wood stain sample, please call Customer Service or e-mail literature@erginternational.com.

METAL INFORMATION

ERG's powdercoat process is superior in quality and has better paint adhesion. We sandblast all metal before powder coating. Please refer to individual product series or collection pricing for available ERG finishes. Custom powder coats are available with upcharge.

METAL FINISHES - SEE PAGE 6 FOR COLORS

Argento Metallic	Charcoal	Oiled Bronze	Polished Chrome
Black Gloss	Charcoal Textured	Olive Gray	Stainless Steel
Black Matte	Gold	Oyster White	
Black Shine	Gray	Patriot Blue	
Black Textured	Gray Beige	Rust Textured	
Black Wrinkle	Liberty Red	Taupe	
Brown Textured	Light Bronze Textured	Tangerine Orange	
Brushed Aluminum (Silver)	Mocha	White Matte	
Canary Yellow	Moss Green	White Textured	
Cappuccino	Navy Blue		

WOOD STAIN INFORMATION

ERG is proud to use only environmentally friendly products in our manufacturing process. All of our wood stains, sealers, glues, adhesives and lacquers are all 100% water based and water soluble products. For an actual wood stain color sample, please call ERG Customer Service with your request. Custom stain match is available with upcharge.

WOOD STAINS - SEE PAGE 7 FOR COLORS

Transparent Stains:

- Apple Red
- Ash
- Bluebird
- Canary Yellow
- Caramel
- Cherry Maple
- Dark Walnut
- Harvest Cherry
- Honey Mustard
- Leaf Green
- Mahogany
- Oat
- Pecan
- Polar
- Medium Walnut
- Natural Maple
- Sage
- Smoky Charcoal
- Sunset Orange
- Ultra Clear Maple
- Violet
- Wengé

ERG STAIN FINISH COLOR / LAMINATE CROSS REFERENCE

When ordering products that mix Laminate with solid Maple wood, ERG suggests the following laminate choices that are similar to ERG's wood stain finish colors.

ERG WOOD STAIN	COORDINATING LAMINATE
CARAMEL	PIONITE HONEY MAPLE WM951-SD
CHERRY MAPLE	WILSONART WILLIAMSBURG CHERRY 7936K-07
DARK WALNUT	WILSONART MONTANA WALNUT 7110K-78
HARVEST CHERRY	WILSONART SHAKER CHERRY 7935K-07
MAHOGANY	PIONITE ROYAL BURGUNDY SP401-SD
MEDIUM WALNUT	FORMICA SORREL CHERRY 5886-43
NATURAL MAPLE	WILSONART KENSINGTON MAPLE 10776-60
PECAN	NEVAMAR SOVEREIGN CHERRY W8325T
SMOKY CHARCOAL	WILSONART SLATE GREY D91-60
ULTRA CLEAR MAPLE	WILSONART MONTECELLO MAPLE 7925-38
WENGE	WILSONART CAFELLE 7933K-07

To obtain a coordinating laminate sample, please call the appropriate laminate manufacturer.

METAL FINISHES

Please refer to individual product series or collection pricing for available ERG finishes.

POWDER COAT PAINT COLORS



white matte



white textured

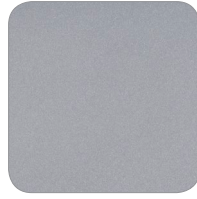

brushed aluminum (silver) gray

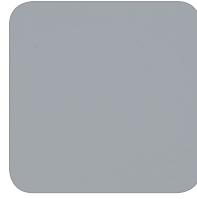

gray

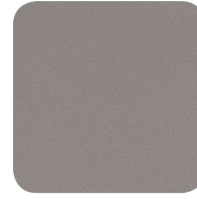

light bronze textured



argento metallic

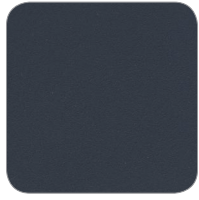

charcoal textured



charcoal



mocha

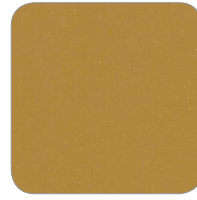

gold



mustard seed



cappuccino



oiled bronze



rust textured



brown textured



black textured



black wrinkle



black gloss



black matte



black shine

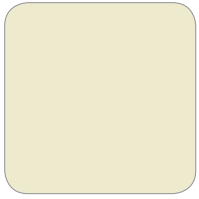

oyster white



gray beige



taupe



olive gray



moss

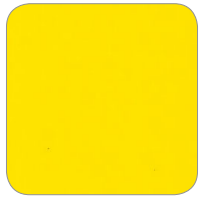

canary yellow



orange tangerine



liberty red



patriot blue



navy blue

OTHER METAL FINISHES



polished chrome



stainless steel

For superior quality and better paint adhesion, ERG sandblasts all metal prior to powder coating.

WOOD STAINS



natural maple



ultra clear maple



oat



caramel



medium walnut



pecan



cherry maple



dark walnut



harvest cherry

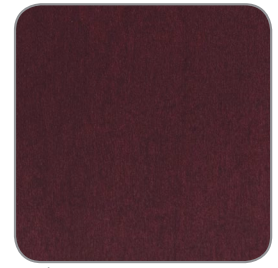

mahogany



wengé



smoky charcoal



ash



polar



apple red



sunset orange

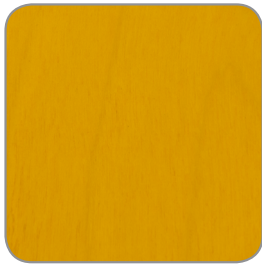

honey mustard



canary yellow



leaf green



sage



bluebird



violet

All ERG wood stains are transparent, water-based, and non-toxic. Above transparent stain color choices are shown on Maple and Beech species. Colors may vary slightly, due to the natural wood tone. Call customer service for more details: 800.446.1186 or e-mail: literature@erginternational.com

TABLE EDGES & PROFILES

3MM PVC EDGES

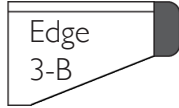
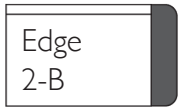

For edge 3-B, please specify knife edge reveal finish: black, white or clear coat.



Solid Color

Almond
Amazon
Black
Burgundy
Charcoal
Cream
Dark Brown
Gray
Khaki Brown
Pepperdust
Sand
White

Coordinating Laminate

Wilsonart Natural Almond D30-60
Wilsonart Amazon D478-60
Wilsonart Black I 595-60
Pionite Plum SP402-9D
Wilsonart Slate Grey D91-60
Wilsonart Alabaster D431-60

Solid Color

Dark Brown
Gray
Khaki Brown
Pepperdust
Sand
White

Coordinating Laminate

Wilsonart Coffee Bean D495-60
Formica Fog 961-58
Wilsonart Khaki Brown D50-60
Wilsonart Pepperdust D327-60
Wilsonart Haze D97-60
Formica Brite White 459-58

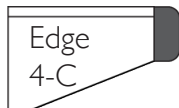
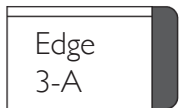

For edge 4-C, please specify knife edge reveal finish: black, white or clear coat.



Woodtone Color

Amber Maple
Ashen Ribbonwood
Beigewood
Bleached Legno
Brazilwood
Chocolate Pear
Colombian Walnut
Crown Cherry
Maple Multiplex

Coordinating Laminate

Wilsonart Kensington Maple I 0776-60
Formica Ashen Ribbonwood 8839-58
Wilsonart Beigewood 7850-60
Formica Bleached Legno 8845-58
Wilsonart Brazilwood 7946-38
Wilsonart Cocobala 7942K-07
Wilsonart Colombian Walnut 7943K-07
Nevamar Crown Cherry W8294T
No Suggestion

Woodtone Color

Monticello Maple
Myriad Ribbonwood
Natural Ribbonwood
Sarum Twill
Silver Metallic
Smoke
Titanium
Walnut Heights
Wild Cherry

Coordinating Laminate

Wilsonart Monticello Maple 7925-38
Formica Myriad Ribbonwood 863-58
No Suggestion
Formica Sarum Twill 8827-58
Wilsonart Satin Stainless 4830K-18
Wilsonart Asian Night 7949K-18
Wilsonart Titanium EV 4810-60
Wilsonart Walnut Heights 7965K-12
Nevamar Sovereign Cherry W8325T

T-MOLD EDGES



RESIN / URETHANE EDGES



NOTES:

6-K and 6-L are urethane on front edge only, 3MM PVC on the remaining edges

Resin/Urethane edges are **only available for certain sizes**, please call customer service for specifications and availability.

Urethane Color

Amazon
Atlantis
Black
Black Walnut
Cardinal
Charcoal

Coordinating Laminate

No Suggestion
Wilsonart Atlantis D25-60
Formica Black 909-58
No Suggestion
No Suggestion
No Suggestion

Urethane Color

Dove Gray
Folkstone
Pepperdust
Soft White
Stone Cliff
Tangerine

Coordinating Laminate

Wilsonart Dove Grey D92-60
Formica Folkstone 928-58
Wilsonart Pepperdust D327-60
No Suggestion
Formica Pumice 858-58
No Suggestion

WOOD EDGES

All wood edges are 1.25" unless otherwise noted.

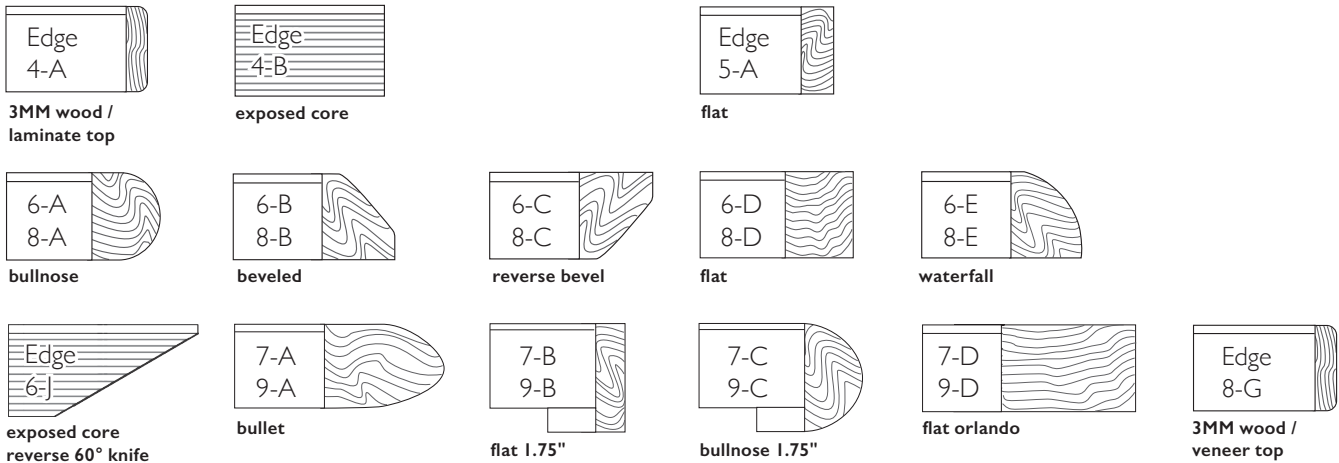

Wood edges are available in all of our standard wood stain colors. Custom stain matching is available with upcharge.

TABLE TOP MATERIALS

LAMINATE



For manufacturers not listed here, please contact customer service: 1-800-446-1186 or sales@erginternational.com

Customer submitted logo/artwork is available on your laminate (through Wilsonart only) with an upcharge and set-up fee.

Ultra-lightweight laminate table tops are also available, made from 100% recovered and recycled wood fiber and are 15% lighter than our standard table tops.

Choose from thousands of laminate selections from brands like Formica, Panolam (includes Nevamar and Pionite), and Wilsonart. To verify if your laminate is standard with ERG, please call or e-mail customer service. Please check with the laminate manufacturer directly for current patterns, colors and availability. Other laminate manufacturers available upon request.



WOOD VENEER

Please contact ERG directly for a quote on veneer tops. Toll Free: 800.446.1186 Email: sales@erginternational.com
See ERG's standard wood stains for available current colors.



BUTCHER BLOCK

Three wood species/finishes are being offered as shown below in 1.5" butcher block table tops. ERG's standard wood stain colors and custom stain matching is also available upon request. Please contact ERG directly for quote on all butcher block tops.
Toll Free: 800.446.1186 Email: sales@erginternational.com



Maple Natural Stain

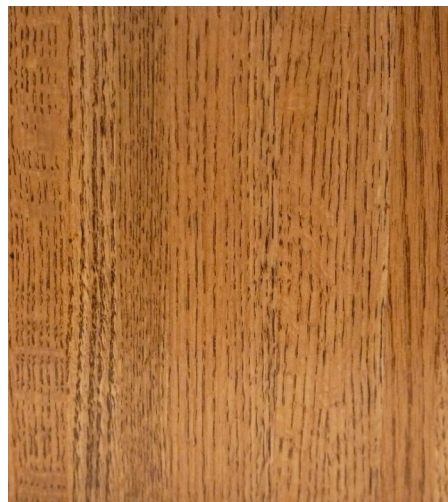

Oak Fruitwood Stain

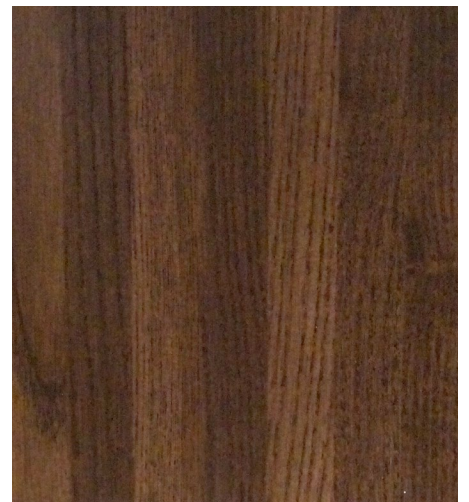

Ash Washburn Walnut Stain

ACRYLIC



Please contact ERG directly for pricing and specs on this item.
Toll Free: 800.446.1186 Email: sales@erginternational.com

KRYSTALCAST®

TOP 10 COLORS

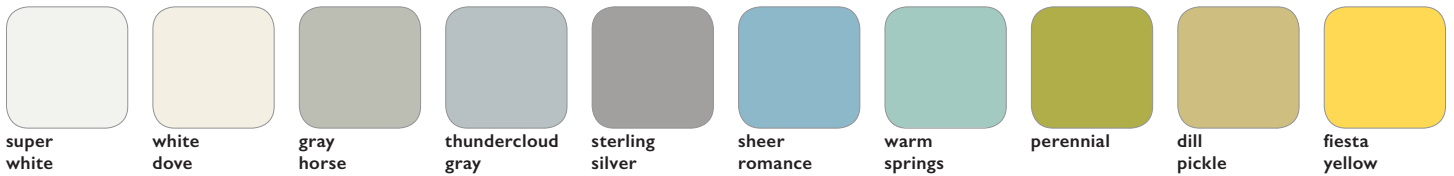

all other benjamin moore paint colors available at no additional charge

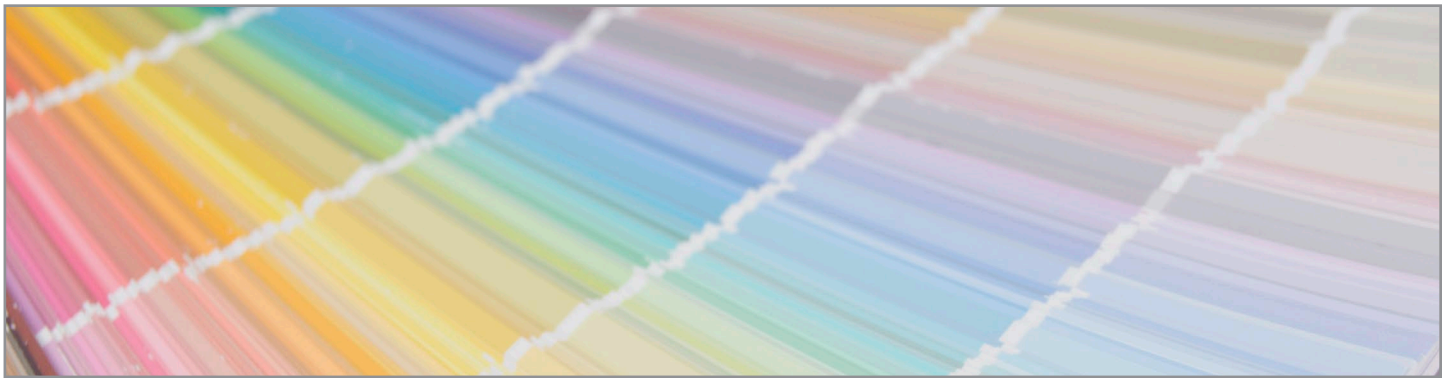

krystalcast® edge profiles:

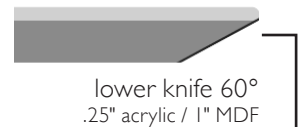
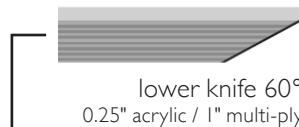
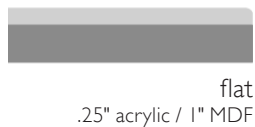
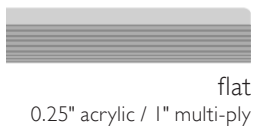
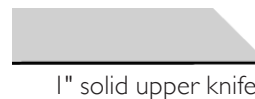

Please specify knife edge reveal finish: black or white

3FORM® CHROMA + VARIA ECORESIN

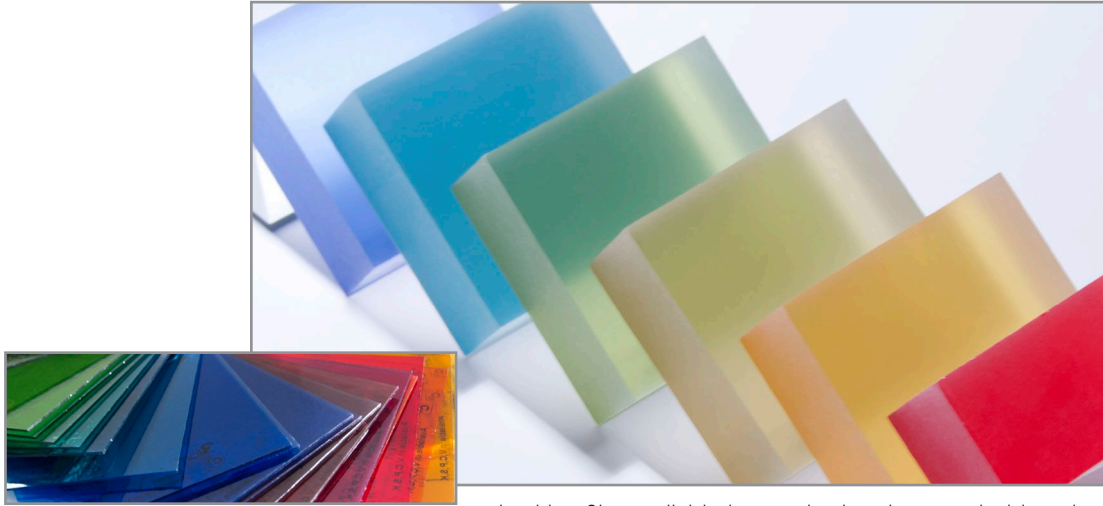

backing film available in standard and customizable colors

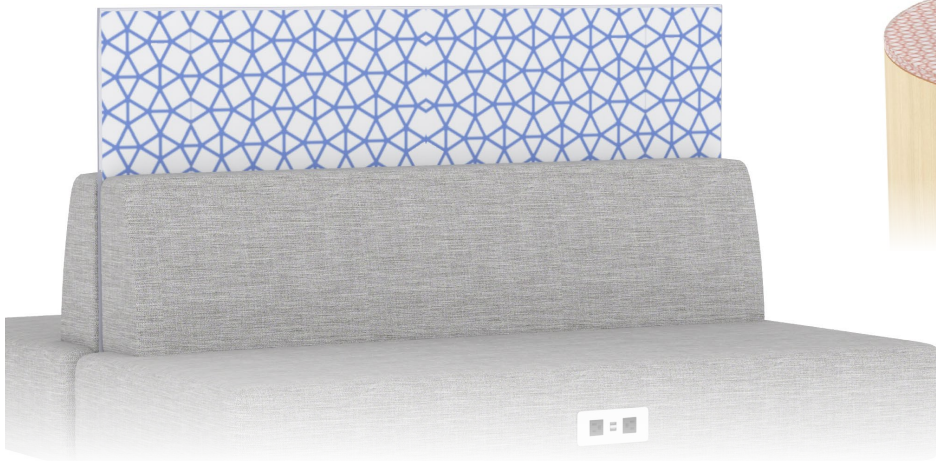

3Form® edge profiles for 1" material (occasional tables: .5"):

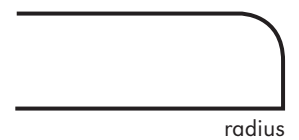
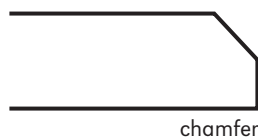

SOLID SURFACE



Please contact ERG directly for pricing and specs on this item. Toll Free: 800.446.1186 Email: sales@erginternational.com
Hundreds of colors, patterns, and brands including: Corian and Zodiaq, Formica, and Wilsonart

Please specify multi-ply sub top paint finish: black, gray, white, beige, or clear coat.

COMPOSITE TABLE TOPS

0.5" edge profiles:



bullnose



double roundover / eased



waterfall

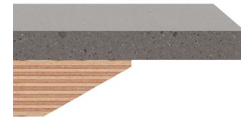

convex



reverse knife 45°

1.5" edge profiles:



bullnose



double roundover / eased



waterfall



convex



reverse knife 45°

NATURAL STONE/QUARTZ TABLE TOPS

standard 0.75" edge profile:



double roundover

standard 1.5" edge profile:

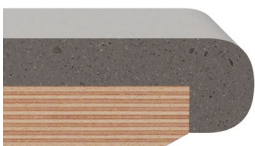

bullnose

1.5" edges available with extra lead time:

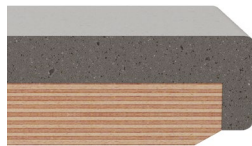

double roundover

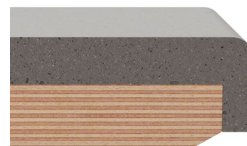

eased edge

SOLID SURFACE

STANDARD CORIAN COLORS

Available for tablet tables and arm caps - see individual product series for options.

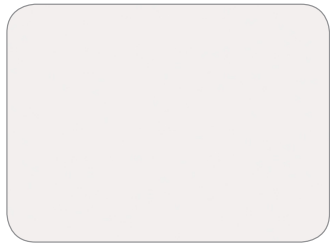

Glacier White

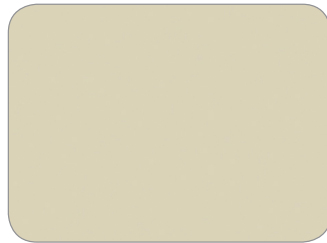

Bone

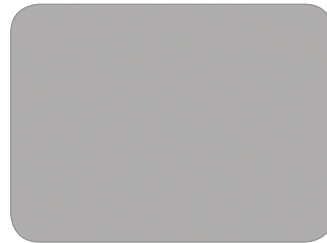

Silver Grey



Bronzite



TABLET TABLES

Tablet tables are available on most lounge and modular products, transforming them into a casual or mobile workspace - see individual product series for available shapes.



ARM CAPS

Solid surface arm caps are available on several seating lines offering durability and contemporary design - see individual product series for availability.

POLY SHELL COLORS

BRIO FLIP (polypropylene)

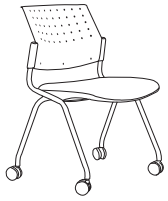

*Brio also available in black or white mesh back with matching poly frame

BRUNO (polypropylene)



ELLIOT (polypropylene)



FORAY (polypropylene)



GOBI (polypropylene)



POLY SHELL COLORS

LOTUS (polypropylene)

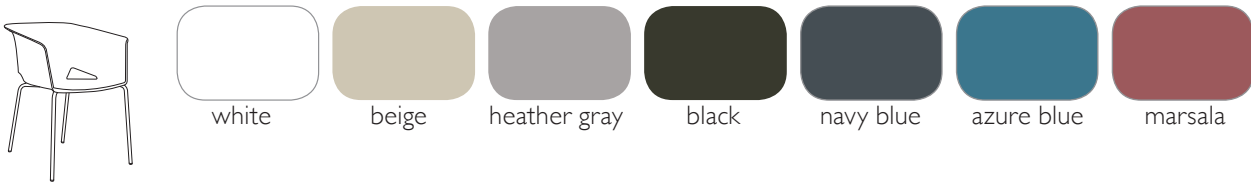

REWIND (polypropylene)

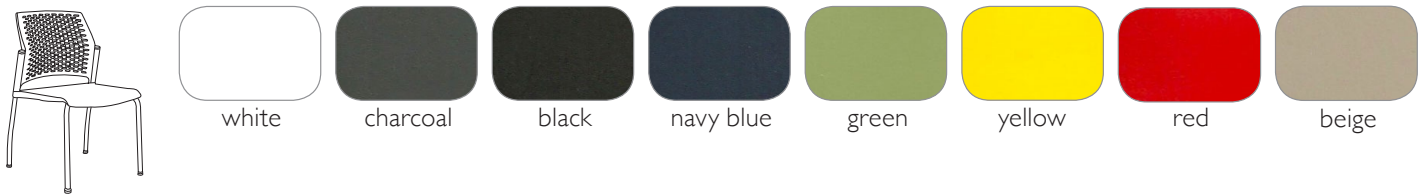

STRIKE (polypropylene)



VESPER (polypropylene)

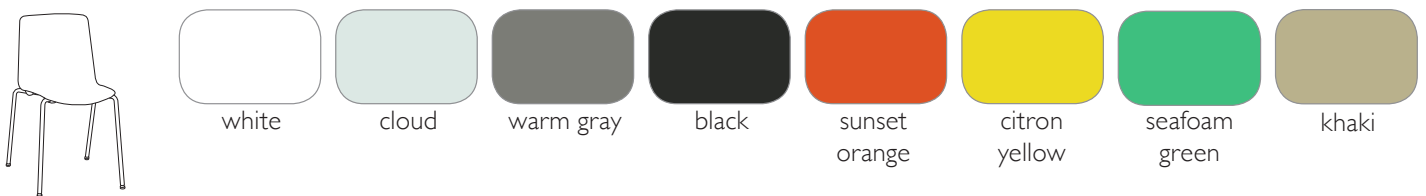

WEBBY (plastic nylon)



FABRIC VENDORS & GRADE INFO



ERG International offers graded in fabrics from several textile companies.
ERG is also pleased to accomodate COM selections.

ANZEA

817-336-2310
anzea.com

ARC|COM

800-223-5466
arc-com.com

ARCHITEX

800-621-0827
architex-ljh.com

CAMIRA

616-288-0655
camirafabrics.com

CARNEGIE

800-727-6770
carnegiefabrics.com

DESIGNTEX

800-221-1540
dtx.com

KNOLLTEXTILES

800-343-5665
knolltextiles.com

MAHARAM FABRICS

800-645-3943
maharam.com

MAYER FABRICS

800-428-4415
mayerfabrics.com

MOMENTUM GROUP

800-366-6839
themomgroup.com

PALLAS

800-472-5527
pallastextiles.com

SINA PEARSON

212-366-1146
sinapearson.com

STINSON

800-841-6279
cfstinson.com

ULTRAFABRICS

914-460-1730
ultrafabricsllc.com

WOLLSDORF

336-884-5005
wollsdorf.com

CARE INSTRUCTIONS FOR ERG FURNITURE PRODUCTS

HOW TO MAINTAIN YOUR ERG TABLES

LAMINATE TOPS/BASES

Clean with a soft non abrasive cloth, sponge or similar material, dry or damp. Clean the laminate surface regularly using Professional Laminate cleaner or warm soapy water. Always clean the surface then dry with blotting paper to avoid any residue marks. Do not use abrasive compounds and cleansing agents which have strong acids or salts. Always keep the tops dry as the moisture is hard on the chipboard core.

WOOD OR VENEER TOPS

Clean with a soft cloth and furniture polish. Mild cleaners or solvents are NOT recommended as all ERG wood stains, lacquers and sealers are all water-based products. It is recommended to dry wood completely until all moisture is gone. Possible liquid or other leftover substances should be removed immediately to avoid absorption.

SOLID SURFACE

Clean with a damp cloth and warm water. DO NOT use cleaners or solvents. Possible liquid or other left over substances should be immediately removed to avoid absorption.

TABLE BASE WITH POWDER COAT FINISH

Clean base with a soft cloth and warm soapy water. Professional cleaning solvents are acceptable and will not damage the powder coat paint finish. Dry completely with soft cloth.

TABLE BASE WITH STAINLESS STEEL FINISH

Clean base with Professional Stainless Steel cleaning solution or warm soapy water. Dry completely with soft cloth.

TABLE BASE WITH POLISHED CHROME FINISH

Clean base with Professional Chrome cleaning solution or warm soapy water. Dry completely with soft cloth.

HOW TO MAINTAIN YOUR ERG CHAIRS

POLY & NYLON CHAIRS

Clean plastic with a soft cloth and warm soapy water. A solution of mild bleach and water, or professional cleaning solvents are acceptable and will not harm plastic materials. Dry completely with soft cloth.

WOOD CHAIRS

Clean with a soft cloth and furniture polish. Mild cleaners or solvents are NOT recommended as all ERG wood stains, lacquers and sealers are all water-based products. It is recommended to dry wood shell completely until all moisture is gone.

UPHOLSTERED LOUNGES & SOFAS

Most fabrics and vinyls can be cleaned with a damp cloth and warm soapy water. Mild professional cleaners are acceptable and will not harm vinyl or fabrics, however please consult textile manufacture for exact cleaning instructions.

CHAIR/LOUNGE FRAME WITH POWDER COAT FINISH

Clean frame with a soft cloth and warm soapy water. Professional cleaning solvents are acceptable and will not damage the powder coat paint finish. Dry completely with soft cloth.

POLISHED CHROME FINISH

Clean frame with Professional Chrome cleaning solution or warm soapy water. Dry completely with soft cloth.



ERG
INTERNATIONAL

www.ERGinternational.com